



WESMARC
DOORS

LOOK BOOK 2022

**OPEN.
TOMORROW.**



Doorways divide and connect worlds.
They form both the first and last impression.
They are quiet in their presence, and yet speak
volumes about the space they secure.
They give you a sense of safety when you enter and
a sense of reassurance when you are out.
They offer a glimpse of life as it could be, and
also of how far a journey it's been.

Doors are the quiet chroniclers of life,
and every time you step through a door,
you pick up a story where you left off.

So, we believe that every time you open a door, you

**OPEN.
TOMORROW.**





YOU DESERVE THE BEST, SO WE MAKE THE BEST.

WESMARC

- Wesmarc Story 01
- Why WESMARC 07
- Expertise Installed 09
- Science Inside Simple Outside 11
- Enter WESMARC 13
- WESMARC Delight Studio 14
- Wood Entrance (Premium) 19
- Wood Entrance (Optimum) 23
- Wood Interior (Premium) 27
- Wood Interior (Optimum) 31
- Full Glass Door Interior 37
- Engineered Wood Frames 43
- Elegant Hardware 46
- Smart Accessories 50
- Dimensions 52
- Design Inspiration 55
- Material Palette 57
- Installation Made Easy 66

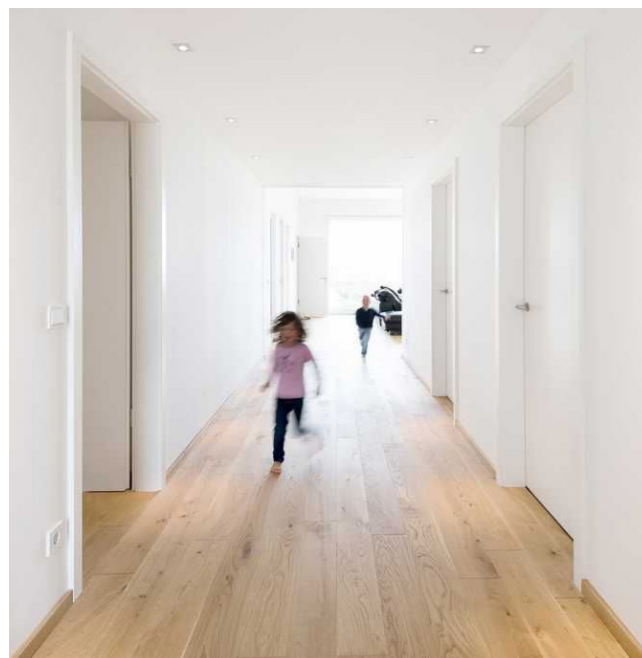

DOORS OF TOMORROW, FOR TODAY.

We create intelligent doors that work as well as they look. Because, we think that doors should not only bring your vision to life with a vibrant dash of colour or a minimal touch of class, but also enhance your everyday experiences.

So, with every door, we endeavour to make homes more intimate, office spaces quieter and public spaces more utilitarian. All while working perfectly time and again.



There is a belief which lies at the core of every WESMARC door: that every door should be safe and durable, work smartly and enhance the aesthetics of the space.



CPL Veneer Dark Oak / Door model A.1

A deep understanding of Indian sensibilities and day-to-day life and a thorough knowledge of the best in European engineering drives everything we create.



LOOKS SOPHISTICATED. FEELS INTELLIGENT.

Yes, our doors are beautiful. However, they go beyond just their appearance, because we understand what is important to you. Your space reflects memories, passions and the security of all that you hold dear. So, we help you choose the full door (door, frame and hardware) that is best suited for you. Which is why, we pay attention to the tiniest of details, and ensure the very best design, safety and durability in every single door.



DESIGN

WESMARC designs come from an appreciation for global trends and contemporary Indian styles. But at their core, our doors are designed to do one thing: to make life easier.

Through a state-of-the-art manufacturing process, and a watchful eye for the best materials, we've created a wide range of doors that is consistently world-class, with no compromise, even at scale. Furthermore, our doorsets can be installed with 2 hands and in just 30 minutes.

DURABILITY

Ever counted the number of times you open and close your door? Well, we have! To make our doors future proof, once the materials have met our standards, we comprehensively test every individual component and then the assembled full door, both mechanically and environmentally. We make sure that every WESMARC door is engineered to withstand the vast differences in usage patterns and environmental conditions, just so it feels like the first time, every time you open the door.



SAFETY

All of our doors are designed intelligently to maximise the safety of the space it encloses, because your safety is important to us. So important, that we make doors that are fire retardant, acoustically insulated or even reinforced with metal sheets. Moreover, every component is crafted to be easy-to-use, but tough to misuse. And we make all of this available to you at a simple half turn of the key. All to make sure that you always have the peace of mind you deserve, on either side of the door.



THE BEST OF THE WORLD, CRAFTED FOR INDIA.

4+ Decades of experience in the Indian construction space and a constant thirst for innovation led us to realize that the market needs a smarter solution when it comes to doors & frames.

So with the aim of shifting the paradigm, we surveyed technologies across the world, and identified the best of European practices. With this as a starting point, we invested over 4 years' worth of effort to develop our own range of products, re-engineered and attested to withstand the vast differences in usage patterns and environmental conditions across our country.



WESMARC STORY

200000 sq. ft

India's most Modern & Largest Door and Frame manufacturing.

2000+ SKUs

Product ranges across wood, engineered and glass.

47+ years of expertise

Across manufacturing, nationwide distribution and creating a leading brand in the Indian building industry.

LEGACY

WESMARC is the continuing legacy of a 3rd generation Indian entrepreneurial family that has a distinct track record for pioneering solutions, disrupting markets and climbing to a position of leadership since 1975.

Behind all of this success, however, is a simple ethos: a thorough understanding of the needs of the customer, a commitment to inculcate the very best practices, an uncompromising passion to execute an elegant solution and ultimately, to elevate the entire ecosystem.



Our high-tech, automated manufacturing unit at Bengaluru.

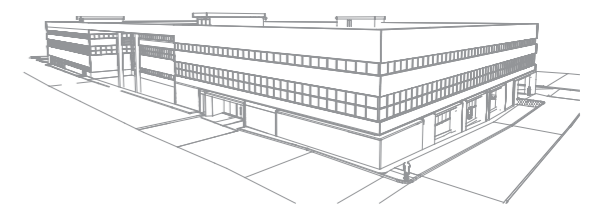

At WESMARC, we don't just make a better product, but we strive to achieve a holistically better way of doing things: from selecting the right full door (door, frame & hardware), to its installation and finally to its everyday use!

We've also made the process of choosing the right full door simple and transparent, because we intend to make life easier, not only by creating doors that are easy to install and use, but also by bringing in simplicity and transparency to the entire process.

WESMARC WALL WRAP ADJUSTABLE FRAME

Eng. wood wall wrap frame :Unique solution on the market wrapping the entire thickness of the wall ranging from 80mm up to 260mm thickness of the wall and comes pre-fitted with a co-extruded acoustic seal within the jamb groove.

Using our telescopic adjustable architraves, each frame size can be further adjusted by up to +20 mm on the thickness of the wall. Architraves are seamlessly joined at 45 degree & are 60 mm wide & 12mm thick. A high level of detail that also adds to the stability of the frame. Furthermore, they are finished with matching CPL veneers that give the impression of the perfectly finished frame creating a PORTAL look.

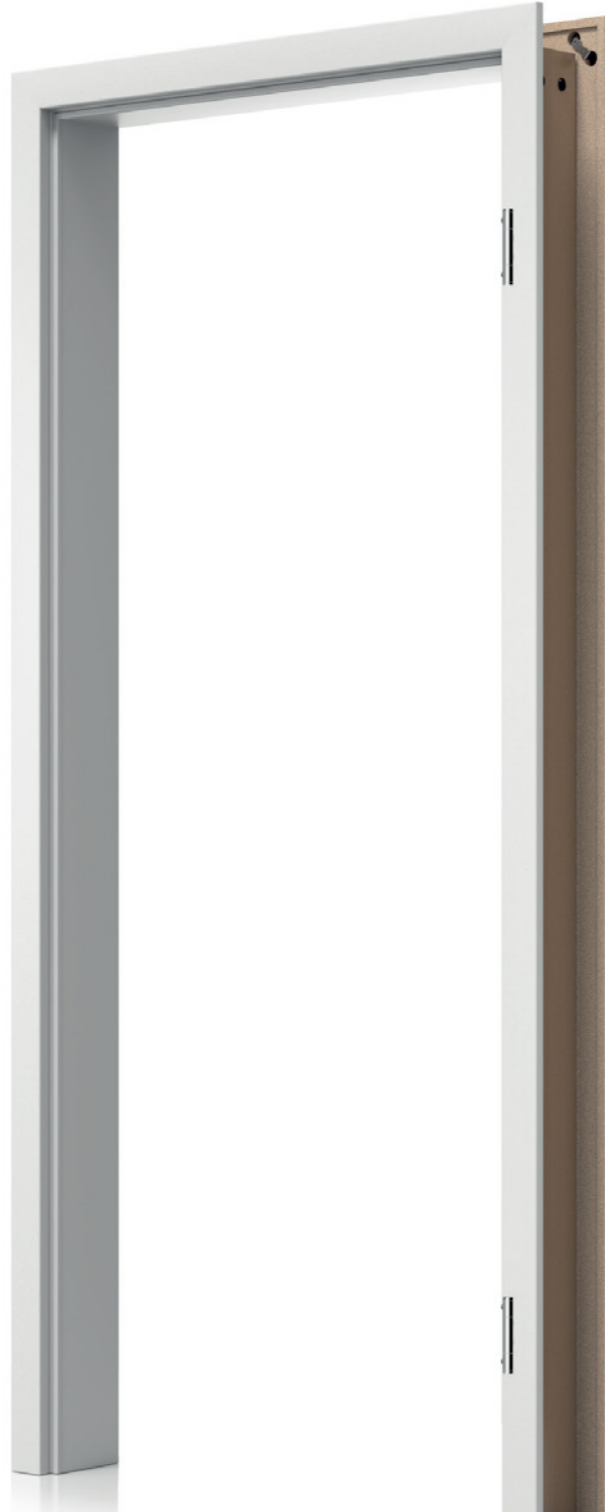

WESMARC FRAME

- Wraps the whole thickness of the wall.
- Door leaf is larger.
- More daylight compared to block frame.
- Allows for high wall tolerances on height (+Any mm/-50mm), width (+30mm/-50mm) & thickness (+20mm/-0mm).



TRADITIONAL/TYPICAL BLOCK FRAME

- Sits within the thickness of the wall.
- Door leaf is smaller.
- Less daylight compared to WESMARC frame.
- Allows for minimum wall tolerances, which will require additional work during installation.

WESMARC REBATED DOOR

Eng. wood rebated doors: Another unique solution on the market is rebated doors (Profiled edges) which add to the modern design of door leaves. This intelligent solution further aids in barricading dust, light, a/c losses & improves acoustic insulation between the rooms. To improve mechanical stability & durability against moisture, our doors are PVC edge banded using PUR glue on all the 4 leading edges.

The rebated profile also allows for easy adjustments, in both width (+/- 2mm) & height (+/- 2mm) between the door and frame to get the perfect & seamless installation, everytime.



WESMARC DOOR

- Rebated doors of thickness 41mm & 45mm.
- Modern design, no gaps with frame, Increasing acoustic insulation.
- Barricades dust, light and a/c losses.
- Opens the door to 180° and easily adjustable in 3D.



STRAIGHT/FLAT DOOR

- Typical door thickness 32/35mm.
- Old design, visible gaps with lesser acoustic insulation.
- Does not barricade dust, light and a/c losses.
- 3D adjustments not possible using traditional leaf/ butt hinges used on straight edge doors.

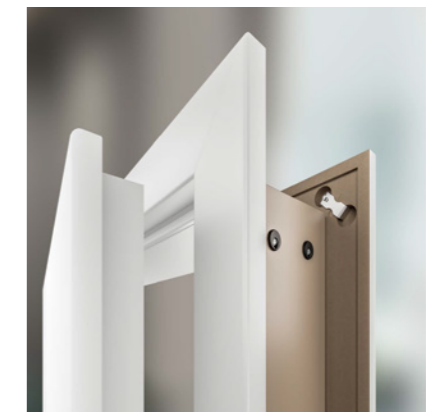

EXPERTISE INSTALLED

We engineer and create doors that are intuitive, so they're both easy to install and also ensure an effortless experience, every day.

DESIGN



WALL WRAP ADJUSTABLE FRAME

Create the PORTAL look.

- Wraps the full thickness of the wall.
- Integrated acoustic seal
- Wraps from 80mm to 260mm.
- Adjustable tolerance up to 20 mm.



REBATED DOORS

What happens inside, stays inside.

- Barricades dust, light and a/c losses.
- Increased acoustic insulation.
- Modern design, no gaps.

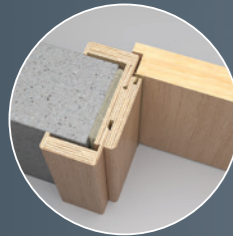

EASE OF INSTALLATION

Simply installed by 2 hands in 30 min.

- Clean installation, no dust, no sound.
- No resizing, polishing or finishing.
- No damage to finished rooms.



CPL VENEERS

Creating the first impression.

- High resistance & durability to scratches.
- Looks and feels like natural veneer.
- No colour variations, no maintenance.

SAFETY



2 ALUMINIUM SHEETS INSIDE

Stands the test of time.

- Reinforced construction.
- Provides additional strength & durability.
- Provides additional insulation.



REINFORCED LOCKS & STRIKER PLATES

Easy to close. Impossible to pick.

- Multi locking Security bolts .
- Reinforced rounded striker plates.
- EN rated Mortise lock & Cylinder.
- Perfectly flush fitted. No protruding elements.

DURABILITY



HINGES

The strong backbone.

- Door ingeniously just hangs on.
- Modern and sleek design. Soft closes the door with ease.
- Opens the door to 180°.
- Easily adjustable in 3D.



PUR ADHESIVE

We think of the little things, for you.

- High resistance to moisture & varying weather conditions.
- Excellent low & high temperature performance.
- Adequately applied across the entire Door & Frame construction.



EXPERTISE INSTALLED



Full Door : Door leaf, Frame (Jamb + Architraves), Hardwares, Accessories & Installation parts

SCIENCE INSIDE SIMPLE OUTSIDE

WESMARC is your one-stop-shop for a full door (door, frame and hardware). The design of our doors brings simplicity and transparency to your decision-making process.

Plug and Play: Every part of a WESMARC door, from the door and frame, right down to the smallest of components is engineered for ease of installation. All the elements are packaged carefully and are ready to install, thus a full door can then be easily installed with just 2 hands and in 30 minutes. No Dust. No Noise. No Damage.

1 Application & Material



Start by identifying where the door is intended to be used & which construction type you prefer or otherwise require. Wesmarc doors are best suited for residences, offices, hotels, hospitals and other commercial spaces, as entrance or interior doorways, in spaces such as bedrooms, bathrooms and others. We build our doors with wood / engineered materials for its intended performance.

2 Dimension & Orientation



Note the height, width and thickness of the clear, finished wall opening where the door is to be installed. Also, determine which way the door should open, and choose a left or right door accordingly.

3 Design & Finish



The easiest step of them all. Simply choose the design or model of the door you want and the CPL veneer finish for the door and frame individually.





CPL Veneer Stained Walnut



CPL Veneer White Ash



CPL Veneer Dark Oak



CPL Veneer Natural Walnut



Natural Eucalyptus



Natural Oak

ENTER WESMARC

WESMARC PRODUCT ARCHITECTURE

■ WOOD

ENTRANCE (PREMIUM)

Created to offer a high level of security at the entrances of apartments, villas, offices and other commercial spaces, this unique set of aluminium sandwiched premium entrance doors are aesthetically sophisticated and incredibly difficult to misuse.

Recommended Applications :
Apartments / Villas / Offices / Hotels / Commercial spaces.

ENTRANCE (OPTIMUM)

The double lock and the security bolts give you a reassuring sense of security, while the modern designs of this effortlessly elegant line of doors gives you both a great first and last impression.

Recommended Applications :
Residences / Offices / Hotels / Commercial spaces.

INTERIOR (PREMIUM)

Built to offer you the quiet sense of calm that the bedroom, office or bathroom demands, these doors are highly secure and also acoustically insulated. Further, the minimal designs can give any space, a facelift.

Recommended Applications :
Apartments / Villas / Offices / Hotels / Commercial spaces.

▲ ENGINEERED

INTERIOR (OPTIMUM)

Versatile, robust and efficient, these doors offer a broad range of applications. They're capable of handling the daily stresses of offices and homes alike. The look of this door can be further enhanced with glass inserts or wood panels.

Recommended Applications :
Bedroom / Bathroom/ Kitchen / Study / Lounge / Office / Pantry / Stores.

INTERIOR FULL GLASS

Best suited for apartments, villas, hotel rooms and other commercial spaces. While they should be welcoming to people, Glass Door is a way to bring more light to every room corner and create the bright and modern interior design.

What's more? These doors are also designed to be a refreshing sight at the shop entry.

Recommended Applications :
Any interior spaces.

FRAME

Wesmarc wall wrap adjustable frame offers superlative quality combined with high-quality derived Eng. construction guarantees excellent dimensional stability and resistance to stress.

The use of a hybrid hinge bracket and the lock plate reinforced into the jamb on the back side for maximum durability and safety.

Recommended Applications :
Any entrance & interior spaces.

OUR DOORS ARE NEVER OUT OF PLACE

The design of our doors brings simplicity and transparency to your decision-making process.

Our doors are crafted to suit any space. So, identify where the door is intended to be used and which construction type you prefer, or otherwise require. Then, choose the design or model you want and the CPL veneer finish for the door and frame.

Our intricate, high-design elements showcase sophistication and modern design. A.1 is a timeless plain design, P.1/P.2 are models with wood filling panels, G.1/G.2 are our models with clear glass, C.1 adds a touch of drama with clear glass & with wood filling panel and F.1 the complete full glass door is the star amongst doors: they open up rooms and perspectives.

Entrance (Premium & Optimum)



Model A.1

Interior (Premium & Optimum)



Model A.1

Interior Full glass door



Model F.1

Interior (Optimum) + Model Doors



Model P.1



Model P.2



Model G.1



Model G.2



Model C.1

WESMARC DELIGHT STUDIO BENGALURU, INDIRANAGAR

In the spirit of making the door & frame-buying process easier for you, we've created a state-of-the-art delight studio so you can go over all of our full door(door,frame and hardware), across all sizes, shapes and applications, under one roof. Because after all, seeing is believing.

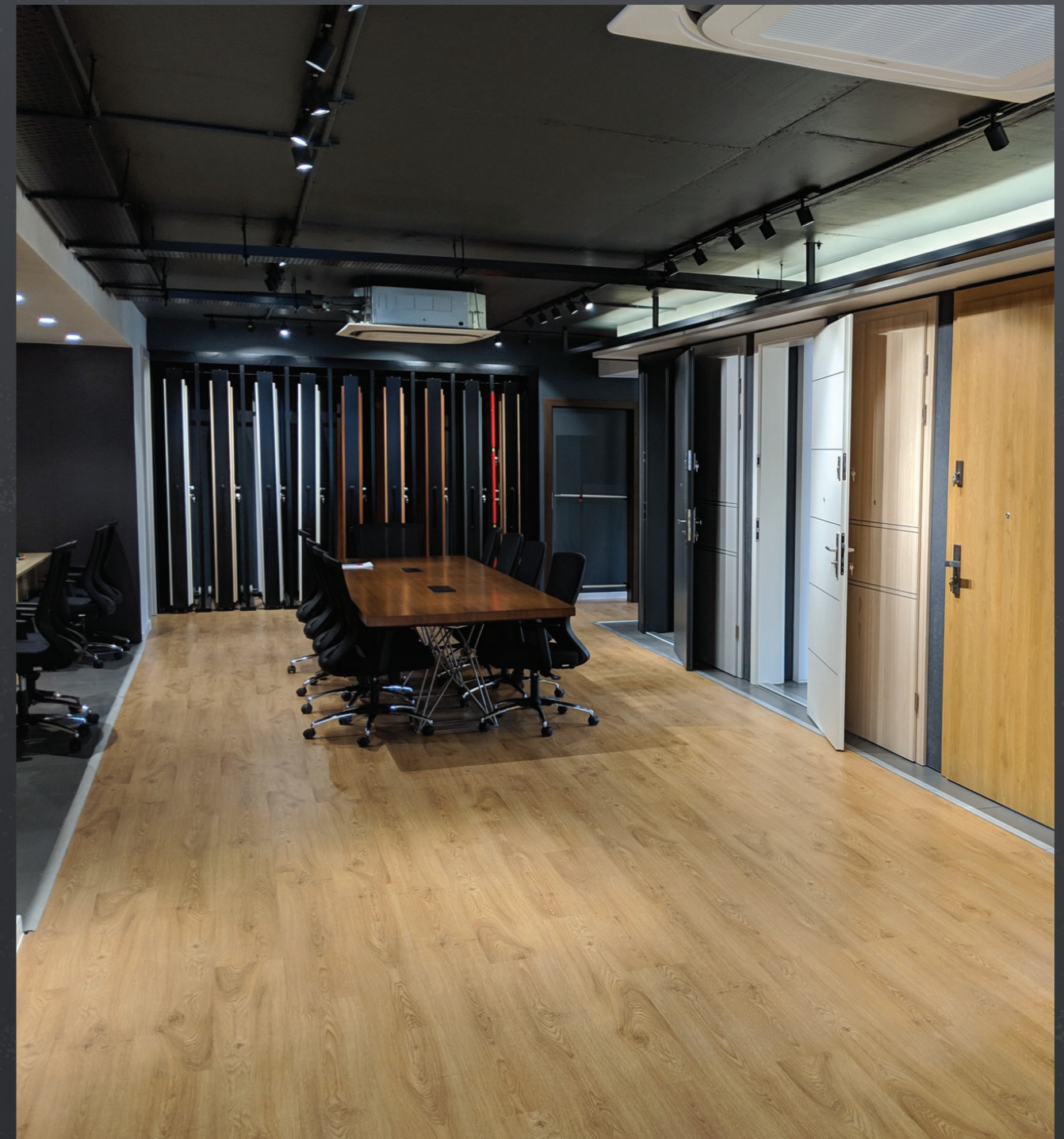

WESMARC STUDIO

We make your selection of a full door an enjoyable experience at our one-of-a-kind delight studio on 100 Ft Road, Indiranagar.



WOODEN DOORS

WOOD ENTRANCE (PREMIUM)

When every space is unique, why should the entrances look the same? Doors welcome you home after a long day at the office, or even welcome you back to the office the following day: they are the cover to your story.

And it is for this reason that we have created a beautiful set of entrance doors, but while these doors are easy on the eye, rest assured, they're incredibly difficult to misuse. In fact, they offer you the kind of superior security that only an Aluminium sandwiched door can promise.

What's more? They can be used in apartments, villas, offices, hotels or indeed, any space that demands a high level of security at the entrance.

Moreover, while the doors promise to stand resolute, they are designed to feel light when opened or closed. They are also finished with a high-quality cpl veneer, so you can be sure that you receive the same welcome every time.

RECOMMENDED APPLICATIONS :

APARTMENTS / VILLAS / OFFICES / HOTELS /
COMMERCIAL SPACES.



CPL Veneer Stained walnut / Door model A.1

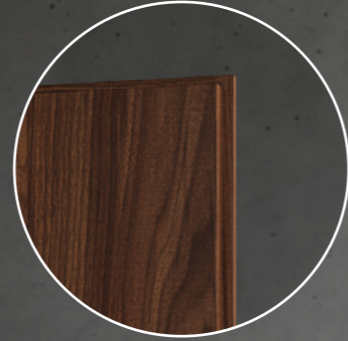

45mm Door with 5.5mm Deck:
Reinforced construction with modern & sturdy profile also enhancing sound insulation.



Aluminium Layer :
Reinforced construction providing additional strength, stability & durability.



2nd Upper Lock :
The additional lock set with the main lock guarantees security for entrances.



WOOD ENTRANCE (PREMIUM)

PRODUCT INFO

Premium solutions for entrances. Its reinforced construction meets the highest requirements of safety, durability and comfort in everyday use.

The doors are additionally sandwiched with 2 layers of AL, which significantly improves its functional and mechanical properties over a longer-term. Additionally, by adding a threshold, this assembly then achieves a sound insulation of +30dB. Externally, The doors are available as a plain design.

DIMENSIONS

Finished Wall Opening Sizes (mm)

Height	Width	Wall Thickness
2350	1000	180 - 200 200 - 220 220 - 240 220 - 260*
	1100	
	1200	

*can be achieved using special + 40mm telescopic architraves available on request

For wall thickness Wesmarc has the standard sizes mentioned in the table above, however upon request we can make frames for all wall thickness sizes from 80mm to 260mm in steps of 20mm.

STANDARD OFFER INCLUDES

- 45mm thick door leaf s/w with 2 AL sheets on 5.5mm HDF decks which are finished with CPL veneer on both sides
- These doors are made with a solid core infill.
- Rebated door profile finished with all 4 sides PVC edge band.
- Full wall thickness wrap around adjustable frames finished with CPL veneer of your choice.
- Integrated perimeter seals and 60mm wide architraves in matching CPL veneer.
- #3 or 4 reinforced 3-element hinges based on the size of the wall opening.
- #2 mortice locks with a rectangular dead bolt adapted for cylindrical door locks.
- #2 cylindrical locks with key-knob configuration & 5 sets of keys each.
- Steel reinforced striker plates for additional safety.
- #3 additional security locking bolts on the opposite side of the door lock.

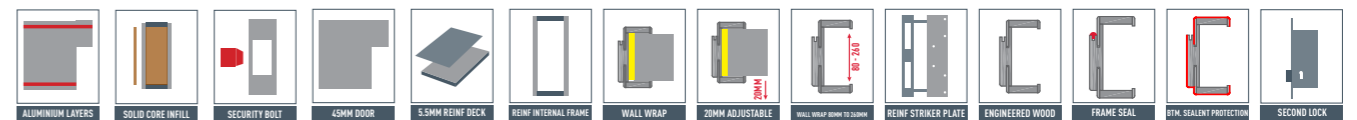

WOOD ENTRANCE (OPTIMUM)

The entrance door is a reflection of your status. And so, it doesn't just require a pleasing design, but also a high level of security and durability. Which is why, we build this door with a solid core infill and is additionally reinforced with 3 security bolts.

Further, these doors are designed to play a role in the styling of your home. Because, in addition to a good first impression, the entrance door is also responsible for a good last impression. After all, the door is the last thing you will see and touch before leaving.

RECOMMENDED APPLICATIONS :

RESIDENCES / OFFICES / HOTELS / COMMERCIAL SPACES.



CPL Veneer Natural Walnut / Door model A.1

WOOD
ENTRANCE (OPTIMUM)



#3 security locking bolts :
Intelligent solution to additionally secure against forced unauthorized opening.



Reinforced Hinges :
Modern & sleek design providing increased stability & durability. Door ingeniously just hangs on & also opens a full 180°.



Solid Core :
Reinforced construction providing additional strength & stability.



PRODUCT INFO

This is our offer for entrance doors to homes, offices, commercial spaces, hotels among others. The door leaf is 41mm thick and is available as a plain design externally finished with CPL veneer of your choice.

DIMENSIONS

Finished Wall Opening Sizes (mm)

Height	Width	Wall Thickness
2350	1000	180 - 200 200 - 220 220 - 240 220 - 260*
	1100	*can be achieved using special + 40mm telescopic architraves available on request
	1200	

Finished Wall Opening Sizes (mm)

Height	Width	Wall Thickness
2100	1000	180 - 200 200 - 220 220 - 240 220 - 260*
	1100	*can be achieved using special + 40mm telescopic architraves available on request
	-	

For wall thickness Wesmarc has the standard sizes mentioned in the table above, however upon request we can make frames for all wall thickness sizes from 80mm to 260mm in steps of 20mm.

STANDARD OFFER INCLUDES

- 41mm thick door leaf on 4mm HDF decks which are finished with CPL veneer on both sides
- These doors are made with a solid core infill.
- Rebated door profile finished with all 4 sides PVC edge band.
- Full wall thickness wrap around adjustable frames finished with CPL veneer of your choice.
- Integrated perimeter seals and 60mm wide architraves in matching CPL veneer.
- #2, 3 or 4 reinforced 3-element hinges based on the size of the wall opening.
- #1 mortice lock with a rectangular deadbolt adapted for cylindrical door lock.
- #1 cylindrical lock with key-knob configuration & 5 sets of keys each.
- Flush fitted and rounded Steel reinforced striker plates for additional safety.
- #3 additional security locking bolts on the opposite side of the door lock.

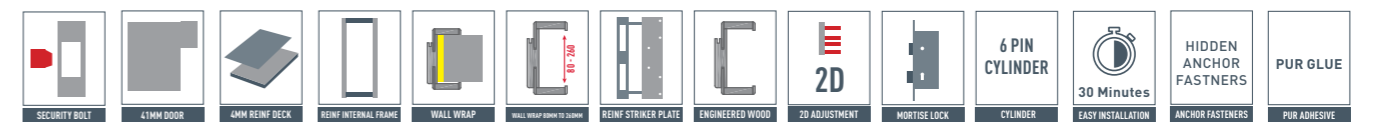

WOOD INTERIOR (PREMIUM)

Regardless of the hours you spend at home, there is always a need for reflecting on the day that has passed or, to regroup for the day to come. Be it at your table in the study, or by the bedside at the bedroom, or maybe even while making yourself a cup of tea in the kitchen.

And of course, this calls for the privacy and silence. So, be sure to make this space yours by separating it from the open areas of the home with a full door. You can even play up the comfort by installing an acoustically insulated wooden door. Further, matching the colours of the door with your furniture will bring a harmony to the space, and the presence of natural feeling engineered wood makes it perfect for a cosy night in. Should you feel the need to personalize the room even further with bold colours, feel free. Because you will surely find a door that fits your imagination.

RECOMMENDED APPLICATIONS :

APARTMENTS / VILLAS / OFFICES / HOTELS /
COMMERCIAL SPACES.



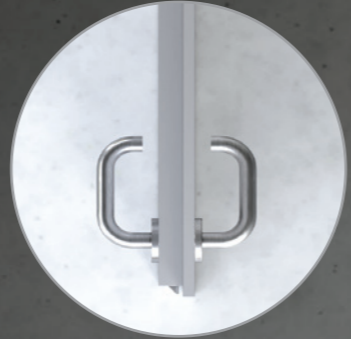

45mm Door with 5.5mm Deck:
Reinforced construction with modern & sturdy profile also enhancing sound insulation.

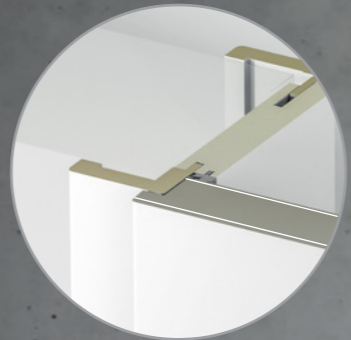

Aluminium Layer :
Reinforced construction providing additional strength, stability & durability.



PUR Adhesive :
High resistance to moisture & varying weather conditions. Adequately applied across the entire Door & Frame construction.



WOOD INTERIOR (PREMIUM)

PRODUCT INFO

Premium solutions for interiors. Its reinforced construction meets the highest requirements of safety, durability and comfort in everyday use. The doors are additionally sandwiched with 2 layers of AL, which significantly improves its functional and mechanical properties over a longer-term. Additionally, by adding a threshold, this assembly then achieves a sound insulation of +30dB. Externally, the doors are available as a plain design with CPL veneer of your choice.

DIMENSIONS

Finished Wall Opening Sizes (mm)

Height	Width	Wall Thickness
2350	900	80 - 100
		120 - 140
		140 - 160
		160 - 180
		180 - 200
		200 - 220
		220 - 240
1000	900	80 - 100
		120 - 140
		140 - 160
		180 - 200
		200 - 220

For wall thickness Wesmarc has the standard sizes mentioned in the table above, however upon request we can make frames for all wall thickness sizes from 80mm to 260mm in steps of 20mm.

STANDARD OFFER INCLUDES

- 45mm thick door leaf s/w with 2 AL sheets on 5.5mm HDF decks which are finished with CPL veneer on both sides.
- These doors are made with a tubular core infill.
- Rebated door profile finished with all 4 sides PVC edge band.
- Full wall thickness wrap around adjustable frames finished with CPL veneer of your choice.
- Integrated perimeter seals and 60mm wide architraves in matching CPL veneer.
- #2 or 3 reinforced 2-element or 3-element hinges based on the size of the wall opening.
- #1 mortice lock with a rectangular deadbolt adapted for cylindrical door lock.
- #1 cylindrical lock with key-knob configuration & 5 sets of keys each.
- Flush fitted and rounded striker plates.

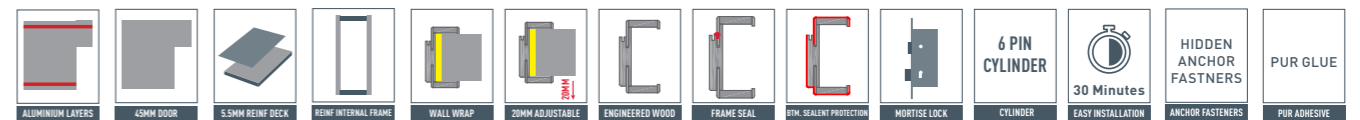

WOOD INTERIOR (OPTIMUM)

Versatile, robust and efficient, these interior doors offer a broad range of applications in homes, offices or other commercial spaces.

They can reflect the energy of your little ones with a pop of colour and can also add a minimal presence to the study or office space, without any compromise to its functionality, reliability, or indeed, its look. Whatever the purpose may be, you will surely find the door that represents you while working perfectly time and again.

To us, a bathroom door has two major characteristics. It should offer you a great deal of privacy, but should also possess a certain finesse in its detailing.

After all, it is where we go to get ready for the day, every morning. So, this line of doors comes with the option of having a beautifully framed glass insert, and also possesses a two-way emergency lock, just to make sure that no nightmares ever breach your self-care routine.

RECOMMENDED APPLICATIONS :

BEDROOM / KITCHEN / STUDY / LOUNGE / OFFICE / BATHROOM / PANTRY / STORES.



CPL Veneer Dark Oak / Door model A.1



41mm Door :
Unique on the market, 41mm thick door leaves provide for a greater stiffness & a stronger barrier to the outside.

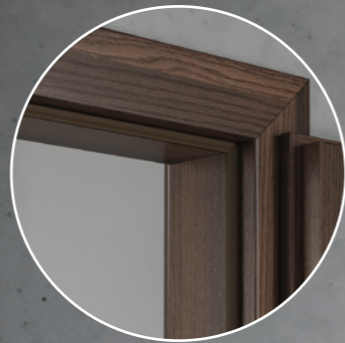

Rebated profile & 4 side Edge band :
Offers incomparably higher resistance and door edge protection than veneer or paint, yet still gives the impression of wood.



Reinforced internal frame :
92mm Stiles & Rails are made of engineered wood which give structural stability and reinforcement for hardware installation.



Model A.1 Model P.1 Model P.2 Model G.1 Model G.2 Model C.1

PRODUCT INFO

Comfort and privacy is of prime importance in bedrooms and other interior applications such as kitchens, study, home office, lounges, bathrooms, pantries, stores and our door sets are designed to fulfil just this need.

Our sophisticated modern designs are available in plain, Glass, Wood or its combination panel models.

DIMENSIONS

Finished Wall Opening Sizes (mm)

Height	Width	Wall Thickness
2350	750	80 - 100
		120 - 140
		140 - 160
		160 - 180
		180 - 200
		200 - 220
900	100	80 - 100
		120 - 140
		140 - 160
		180 - 200

Finished Wall Opening Sizes (mm)

Height	Width	Wall Thickness
2100	750	80 - 100
		120 - 140
		140 - 160
		160 - 180
		180 - 200
		200 - 220
900	100	80 - 100
		120 - 140
		140 - 160
		180 - 200

For wall thickness Wesmarc has the standard sizes mentioned in the table above, however upon request we can make frames for all wall thickness sizes from 80mm to 260mm in steps of 20mm.

STANDARD OFFER INCLUDES

- 41mm thick door leaf with 4mm HDF decks which are finished with CPL veneer on both sides.
- These doors are made with a tubular core infill.
- Rebated door profile finished with all 4 sides PVC edge band.
- Full wall thickness wrap around adjustable frames finished with CPL veneer of your choice.
- Integrated perimeter seals and 60mm wide architraves in matching CPL veneer.
- #2 or 3 reinforced 2-element or 3-element hinges based on the size of the wall opening.
- #1 mortice lock with a rectangular deadbolt adapted for cylindrical door lock.
- #1 cylindrical lock with key-knob or coin-knob (bathrooms) configuration & 5 sets of keys each.
- Flush fitted and rounded striker plates.



INTERIOR (OPTIMUM)

WOOD



 **ENGINEERED DOORS**

Full Clear glass, Door model F1

INTERIOR FULL GLASS DOOR

Homes, offices, and public spaces alike could call for exceptional requirements. While they should be welcoming to people, full Glass Door is a way to bring more light to every room corner and create the bright and modern interior design.

Dare to make a statement with your full glass door in terms of living ambiance. Frames give shape to your fantasies. Because after all, they are the home to treasured memories, friends, and family. The frame and the related hardware are built for visually increasing home interiors or office spaces and giving the impression of lightness. A wide range of design possibilities makes these specialist doors quite an attractive proposition.

RECOMMENDED APPLICATIONS :

PUBLIC SPACES / RESIDENCES / OFFICES / SHOP FRONTS



welcome: (verb)*
to greet the arrival of a person with pleasure and courtesy.



10mm Glass : Toughened safety glass (TSG). Durable & less susceptible to scratches, wear and tear.



Reinforced Hinges : Modern & sleek design providing increased stability & durability. Door ingeniously just hangs on & also opens a full 180.



Interchangeable Frame : This frame is interchangeable between full glass doors & our interior wood doors.



PRODUCT INFO

The full Glass Door leaf version in the WESMARC collection comes with 3D adjustable, 2 Element hinges : designed to be visible once the door is closed, for beautifully seamless results, even with the door open, allowing it to be opened a full 180 degree. The door frame is warped onto the wall and ceiling finished with CPL veneer.

DIMENSIONS

Finished Wall Opening Sizes (mm)

Height	Width	Wall Thickness	Height	Width	Wall Thickness
2350	750	80 - 100 120 - 140 140 - 160	2100	750	80 - 100 120 - 140 140 - 160
	900	160 - 180 180 - 200 200 - 220		900	160 - 180 180 - 200 200 - 220
	1000	220 - 240		1000	220 - 240

For wall thickness Wesmarc has the standard sizes mentioned in the table above, however upon request we can make frames for all wall thickness sizes from 80mm to 260mm in steps of 20mm.

STANDARD OFFER INCLUDES

- 10mm tempered glass completely clear, which can be additionally frosted for privacy with frosting stickers.
- Full wall thickness wrap around adjustable frames finished with CPL veneer.
- Integrated perimeter seals and 60mm wide architraves in matching CPL veneer.
- #2 or 3, reinforced 2-element glass door hinges.
- #1 All in one knob-key lock with deadbolt adapted for glass doors, and 3 sets of keys.





 **ENGINEERED FRAME**



Perimeter Frame seal :
High quality co-moulded & extruded seals ensures comfort of use by soft closing the door and improving acoustic insulation.



Architraves : 60 mm wide & 12mm thick architraves are finished with matching CPL veneers and give the impression of the perfectly finished frame.

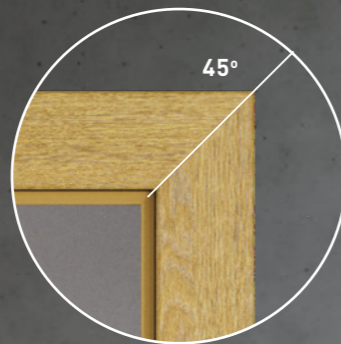

Mitre frames at 45° :
Architraves are seamlessly joined at 45°. A high level of detail also adds to the stability of the frame.

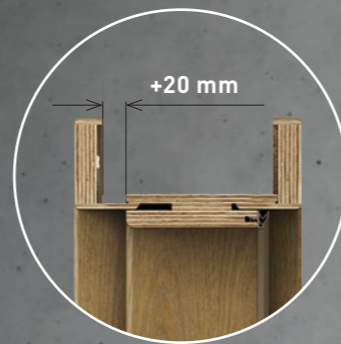

Eng. wood wall wrap frame :
Unique solution on the market wrapping the entire thickness of the wall. Can be adjusted up to 20 mm.



Striker plate : Perfectly fitted without any protruding elements. Reinforced with steel plates and slots finished with stiff plastic end caps.



PUR Adhesive :
High resistance to moisture & varying weather conditions. Adequately applied across the entire Door & Frame construction.

PRODUCT INFO

Frames add all the detail and value to a well-designed interior. It's the little things that count. To compliment a high-design door, one needs an even more sophisticated and intelligent frame.

A well-designed frame covering the entire thickness of the wall, the possibility of adjustment up to 20mm and extremely easy and quick installation make our product unique in the market.

All our frames are integrated with a perimeter acoustic seal and are offered with 60mm wide architraves in matching CPL veneer to the main frame.

DIMENSIONS

Finished Wall Opening Sizes (mm)

Wall Thickness	Architraves
80-100	60
100 - 120 (Upon request)	60
120-140	60
140-160	60
160-180	60

Wall Thickness	Architraves
180-200	60
200-220	60
220-260*	60

*can be achieved using special + 40mm telescopic architraves available on request

- Wesmarc makes two finished wall opening heights of 2100mm & 2350mm.
- Wesmarc makes two finished wall opening widths of 750mm, 900mm, 1000mm, 1100mm & 1200mm.

WALL WRAP ADJUSTABLE FRAME

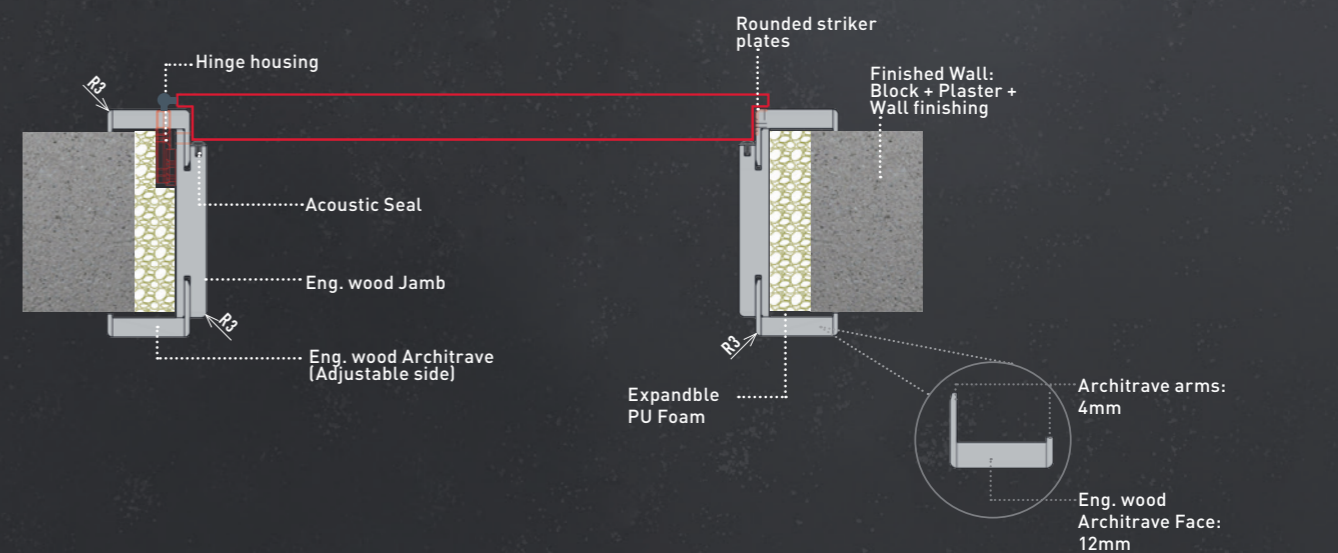
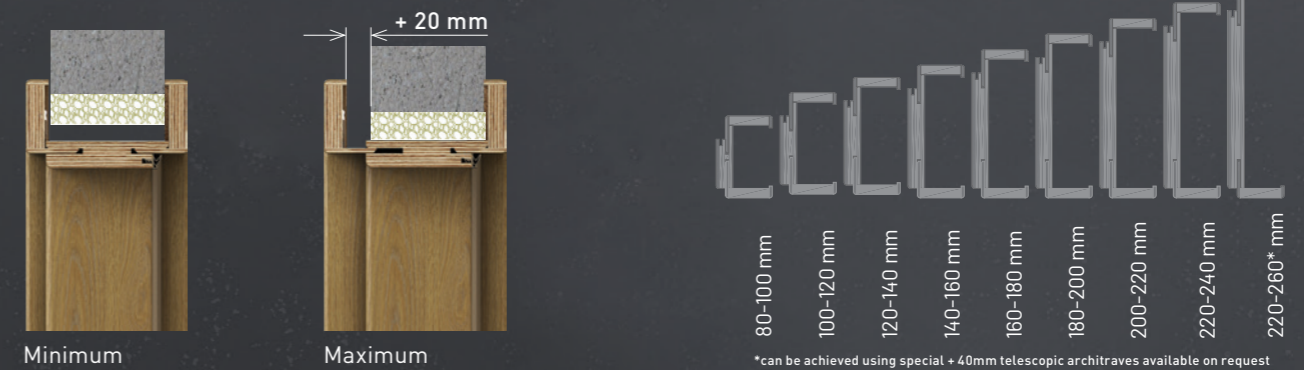



ELEGANT HARDWARES. EVERY DAY.

While we understand the importance of having elegant hardware, it's about a lot more than outward appearance.

It is also about the inner peace you get from having a solid, secure metalware.

HINGES: Modern & Sleek design that allows for the door to ingeniously "hang on" the frame



2 Element Hinge

2E Hinge

- Opens the door to 180°.
- Easily adjustable in 3D.
- Can add-on hinge caps.



3 Element Hinge

3E Hinge

- More weight bearing capacity.
- Opens the door to 180°.
- Easily adjustable in 2D.
- Can add-on hinge caps.

SECURITY BOLTS: Intelligent solution to additionally secure against forced un-authorized opening



Security Bolts : #3 No.s

Security Bolt

- Multy locking Security bolts.
- Provides additional locking strength.
- Reinforced rounded striker plates.
- Perfectly flush fitted & no protruding elements.

HINGE BRACKETS: Allows for easy hinge mounting on the reverse side of the frame



2E/3E hinge mounted on bracket

Adjustable hinge bracket

- Compatible for both 2E & 3E hinge .
- 6 screws allows for sturdy installation .
- Reinforced nylon + GF body.

STRIKER PLATE



Reinforced rounded striker plate

Reinforced striker plate

- 1.5mm stainless steel round profile.
- Finished with stiff plastic end caps .
- Reinforced with 2mm thick steel plates.

MAIN LOCK



EN rated heavy duty mortise lock

Mortise main lock

- Double through dead-bolt 21mm.
- Round forend plate .
- Fully enclosed body.

UPPER LOCK

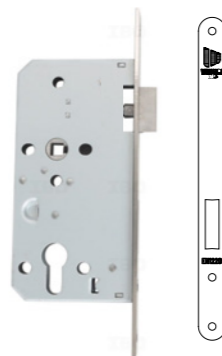

EN rated heavy duty mortise lock

Mortise 2nd lock

- Double through dead-bolt 21mm.
- 10mm thick dead-bolt .
- High grade lock EN12209.

CYLINDER



6 pin security euro cylinder + 5 keys

Euro profile cylinder

- 5 computer cut ultra-security keys.
- Offset Euro Cylinder in full brass body with 6 pins.
- Cylinder Body : satin steel finish
- 200000 cycles Tested.

IRONMONGERY AND LOCKS



Key-Key type cylinder

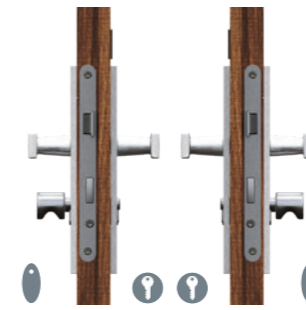

Knob-Key type cylinder Key-Knob type cylinder

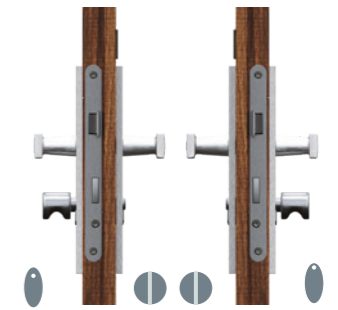

Knob-Coin type cylinder Coin-Knob type cylinder

FRAME SEAL



Co-extruded acoustic seal

Frame seal

- Soft closes the door with ease.
- Provides additional acoustic insulation.
- Barricades dust, light and A/C losses.

FRAME INSTALLATION



Architrave clamp



Jamb connecting pins



Dowel



Anchor bracket

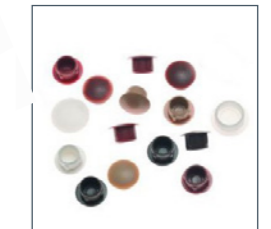

Closing cap



WE THINK OF THE LITTLE THINGS FOR YOU

THRESHOLDS: 304 Stainless steel low profile threshold with integrated acoustic soft close seal.



90mm wide SS threshold with internal anchoring plate

STAINLESS STEEL THRESHOLD

- Durable, convenient and sleek low profile.
- Provides additional acoustic insulation.
- Integrated rubber seal.

WESMARC DOOR CLOSER



Wesmarc Door closer

DIY: Do It Yourself door closer

- Install in under 1 minute & no tools.
- 3- Speed adjustable.
- Opens the door 90°.
- No drilling no damage to the door.

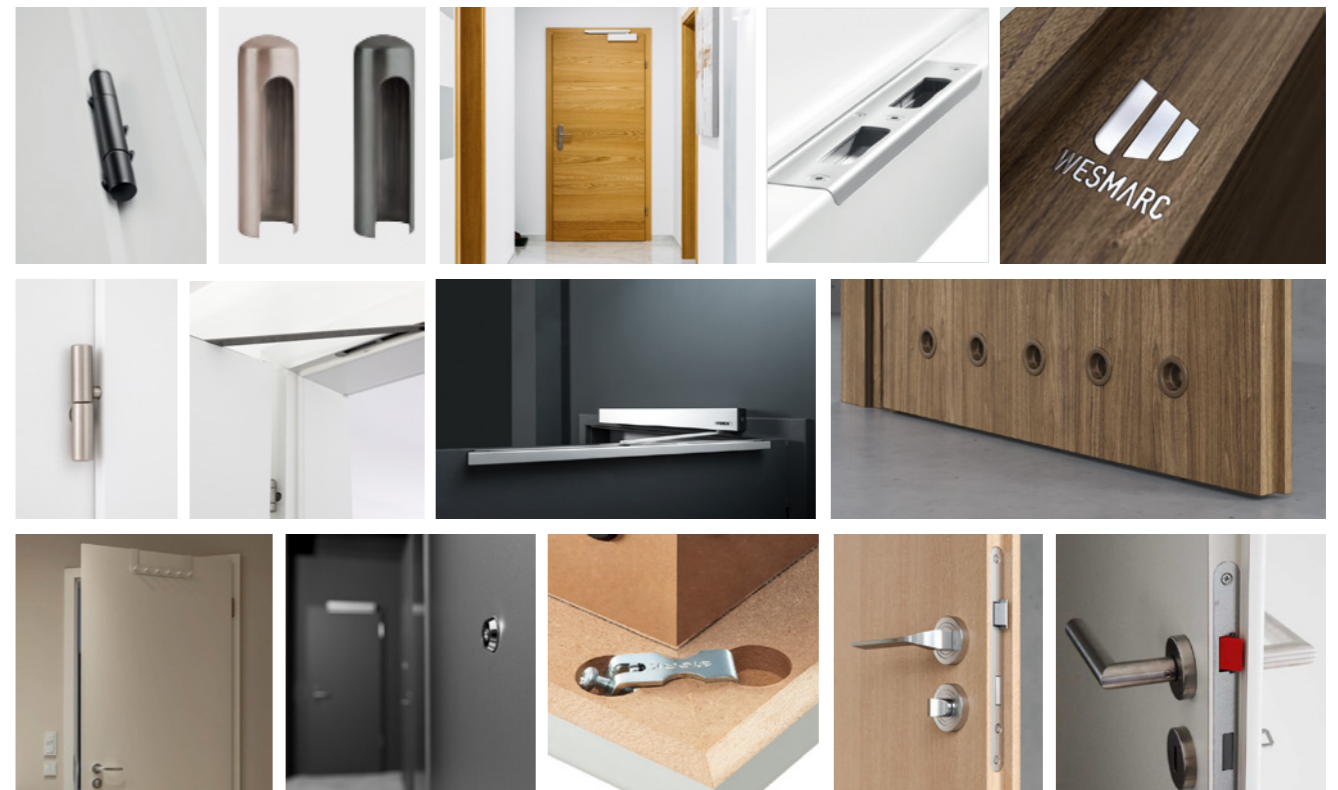



DIMENSIONS

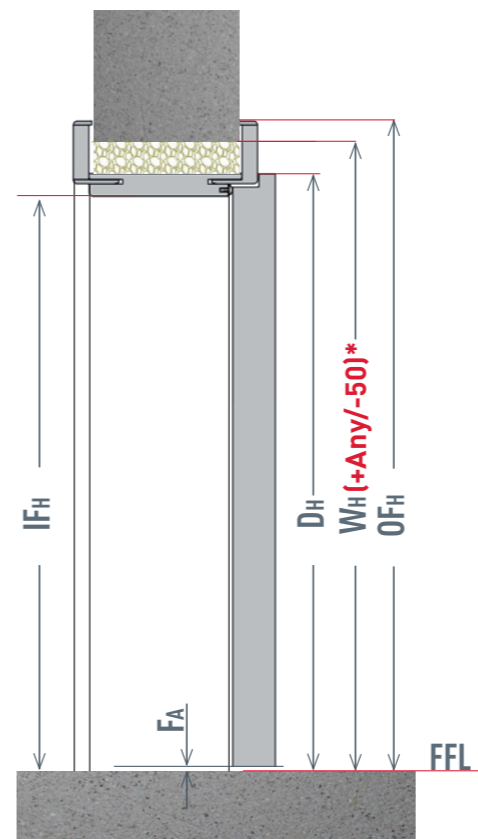
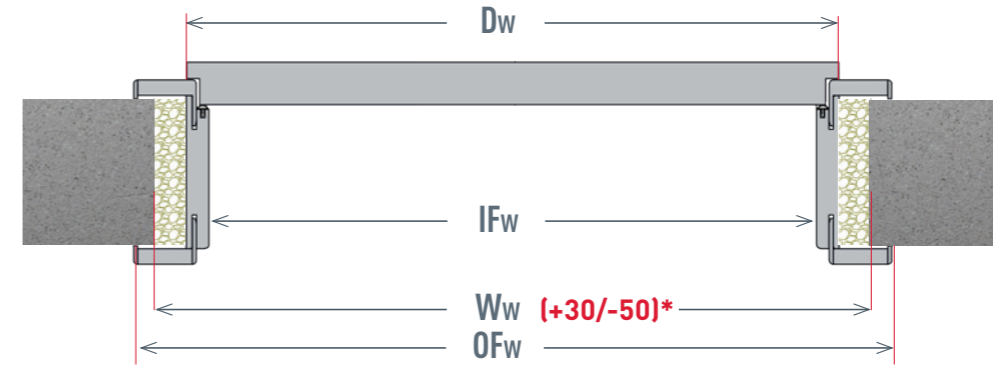

Legend

Sl No.	Description	Code
1	Height of Finished W all Opening	W_H
2	Width of Finished W all Opening	W_w
3	Height of D oor Leaf	D_H
4	Width of D oor Leaf	D_w
5	Height I nside F rame	I_{Fh}
6	Width I nside F rame	I_{Fw}
7	Height O utside F rame	O_{Fh}
8	Width O utside F rame	O_{Fw}
9	D oor Thickness	D_{Thk}
10	F loor allowances	F_A

* Maximum & Minimum allowable wall tolerances with available wall extensions on both sides.

** Maximum & Minimum allowable wall tolerances without wall extension on 1 side.
 Width (+30mm/-20mm)
 Height (+Any/-0mm)

Finished Wall Opening Sizes (mm)

Sl No.	$W_h +Any / -50$	$W_w +30/-50$	$D_h \pm 3$	$D_w \pm 2$	$I_{Fh} \pm 3$	$I_{Fw} \pm 2$	$O_{Fh} \pm 3$	$O_{Fw} \pm 2$	$D_{Thk} +0.5/-1$	$F_a \pm 1$
1	2100	750	2043	680	2028	638	2100	782	41/45	6.5
2	2100	900	2043	830	2028	788	2100	932		
3	2100	1000	2043	930	2028	888	2100	1032		
4	2100	1100	2043	1030	2028	988	2100	1132		
5	2350	750	2293	680	2278	638	2350	782		
6	2350	900	2293	830	2278	788	2350	932		
7	2350	1000	2293	930	2278	888	2350	1032		
8	2350	1100	2293	1030	2278	988	2350	1132		
9	2350	1200	2293	1130	2278	1088	2350	1232		



DESIGN INSPIRATION

We think doors are far more than just a means to separate one space from another. We think of it as a key part of the interior decor.

So, we've made the process of choosing doors, a joyful activity. Here are some tips to help you choose the doors that add to the character and look of your living space.

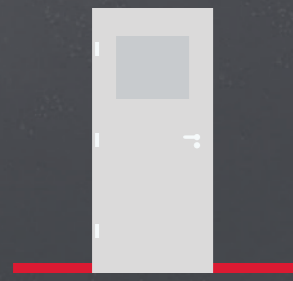

FIT IT TO SKIRTING BOARDS

Doors can be accented beautifully by the skirting boards that line the wall. So, observe the colour, height, finish, and style of the boards and choose your doors and frames accordingly.



FIT IT TO DETAILS

When it comes to styling a room, the devil is in the details. So take your cues from the detailing of your room and choose a door and frame that works well to highlight them.

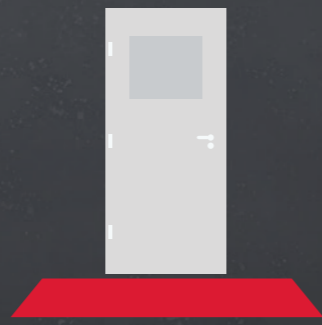

FIT IT TO COLOURS

Another great anchor point for the design of a space is the floor or wall colour. Match the doors and frames to the shade of the floor or wall, or, go the opposite way for a contrasting colour palette.



FIT IT TO FURNITURE

The character of the room is underscored by its furniture, and doors are a big part of it. Match the finish of your doors and frames to complement the structure and shade of your furniture.

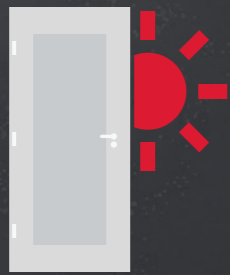

FIT IT TO LIGHTING

The beauty of a room really comes out when soaked in natural light. And when there is little daylight access, the room can be lit up thanks to glass doors.

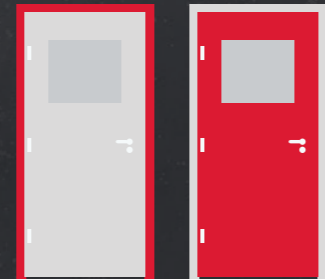

FIT IT TO STYLE

There is no wrong way of styling an apartment. They can be minimal or loud, while still having a distinct style. So make sure you choose the doors and frames that play along with your style.

LEFT OR RIGHT?

An aspect of buying a door that is often overlooked until the last minute is its orientation and direction of opening. In other words, do you need a left or right door?

How do you determine whether the door is a left or a right door?



1. Locate which side of the frame the hinge is on.



2. Stand between the frames facing directly towards the hinge.



3. If the door opens towards your Left, its a left arm stretched out door.

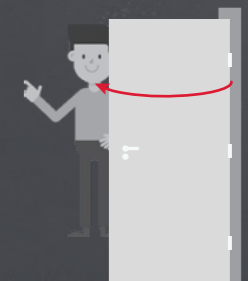

4. If the door opens towards your Right, its a right arm stretched out door.



Look from one side.



Look from the otherside.

FLUSHED OR REBATED?

CREATING FIRST IMPRESSIONS

MATERIAL PALETTE HIGH QUALITY CPL VENEERS

Not many things are as unpredictable as the Indian weather and usage patterns.

A vast geography, leading to vast differences in weather conditions and an equally vast difference in how the doors are used across, demanded a range of materials that stand resolute. So, we combined a consistently high-level of functionality with elegance.



Dark Oak



Stained Walnut



Natural Walnut



Natural Eucalyptus



Natural Oak



White Ash

MATERIAL PALETTE

Abrasion



Doors and frames are exposed to abrasion every day. So, naturally, the veneer that covers it must withstand the energy of our children and the scratches of our pets as they wait for us. So, we use only high quality CPL veneers, which is incomparably much more abrasion-resistant compared to natural veneer.

Humidity



Humid weather is just as unpleasant to our doors as it could be, to us. They lead to a swelling of the doors, causing them to drag on the floor or against the frame. The first line of defence against humidity is the outer veneer. So, for a superior stability and protection, we only use CPL veneers that do not absorb any moisture.

Cleaning Products



The usage of doors across our country involves regular cleaning with wet and soapy cloths. These factors, over time, naturally have an ill affect on the durability of the door surface. Which is why, WESMARC doors are designed such that they don't need to be cleaned nearly as often.

Diffused Sunlight



There aren't many things harsher on a door than an Indian summer. So much so, that discolouration of doors is commonplace. But that didn't deter us from testing all our doors for their reaction to diffused daylight. And we are proud to say, that they achieve high colour stability throughout their lifespan.



Dark Oak

Stained Walnut



Natural Walnut

Natural Eucalyptus



Natural Oak

White Ash



INSTALLATION MADE EASY



STEP 1

Glue and assemble the factory finished vertical elements of the frame to the horizontal with the provided screw and clamp assembly.

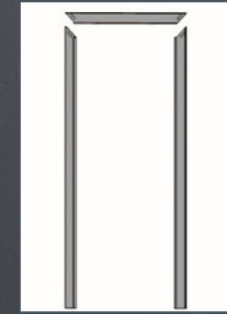

STEP 4

Now, for the reverse side, the factory finished architrave is easily assembled the same way using glue, screws and clamps. The result is a firmly jointed & perfectly finished 45° edge.

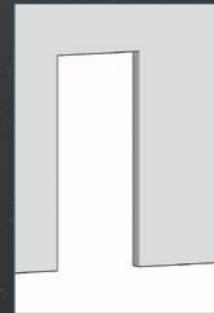

STEP 2

Our unique hinges lock to the architrave by just tightening its screw. Then the entire frame assembly is placed within the wall opening and aligned.

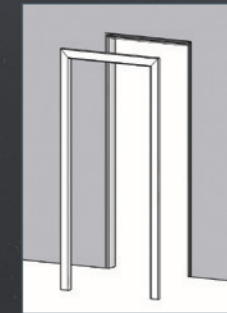

STEP 5

This is then simply push fixed with some glue into the slotted groove in the main frame.

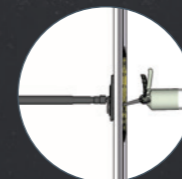

STEP 3

Stability bars are clamped on and then, using a gun, expanding PU foam is filled to cover the gap between the frame and the wall.



STEP 6

Finally, the factory finished door leaf with its pre-installed lock and hinge is literally just hung onto the hinge on the frame. Millimeter alignment precision can be achieved in 3D by a simple adjustment of the hinge screw using just a screwdriver.

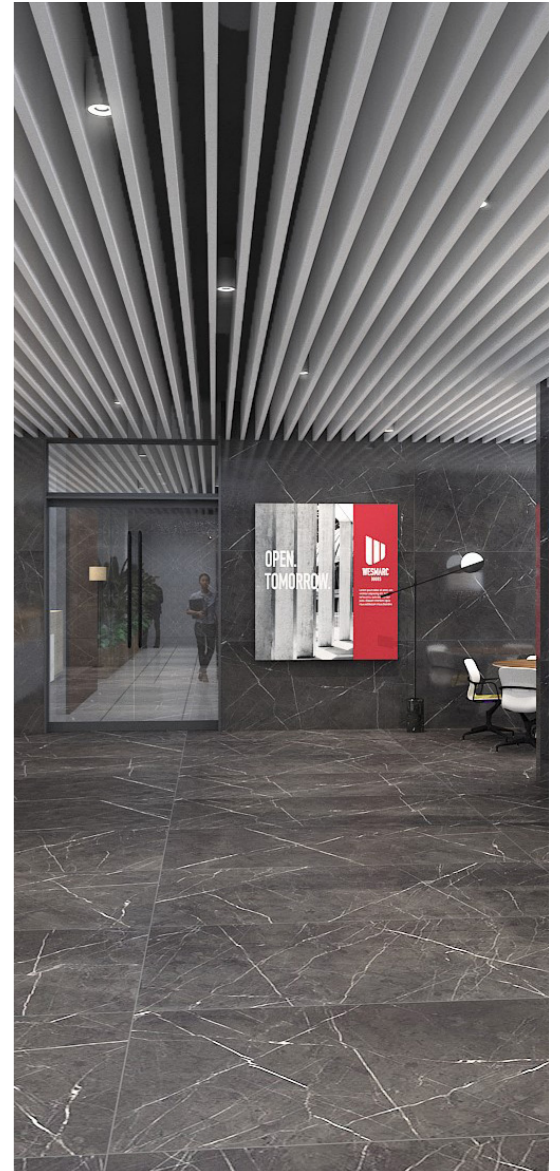



WESMARC DOORS

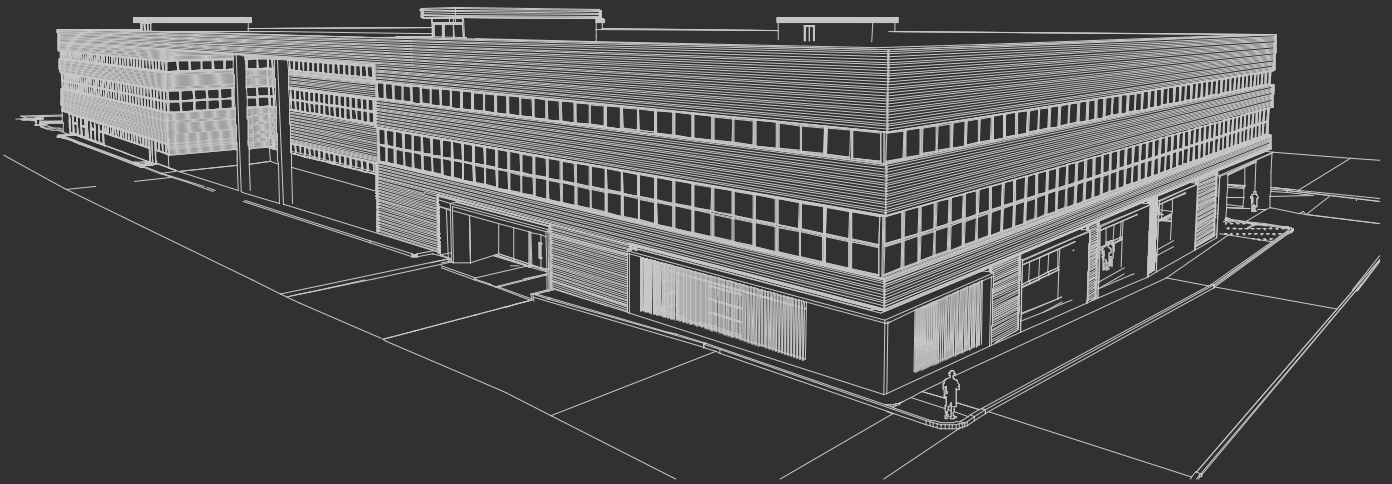

INDIA'S MOST
MODERN & LARGEST
DOOR & FRAME MANUFACTURING

VISIT OUR FACTORY

Wesmarc Doors Technik Pvt Ltd

#61/B1, 61/B2 & 61/C

Bommasandra Industrial Area, Bengaluru- 99

Tel: 9880918981. E-Mail: info@wesmarcdoors.com

VISIT OUR DELIGHT STUDIO

Wesmarc House

#2023, 2nd Floor, 100 Ft Rd

Indiranagar, Bangalore-08

Tel: 9880918981. E-Mail: info@wesmarcdoors.com